

Owner's Manual

Commander™ Tachometer



- Analog Tachometer
- Digital displays for:
 - Hours Engine Has Been Run
 - Fuel Level
 - Suzuki Warning messages
- Fuel Management
 - Fuel Flow in GPH or LPH
 - Total or Trip Fuel Used
 - Low Fuel Alarm
 - Calculates Fuel Remaining In Tank

Important

 **WARNING**

 **CAUTION**

NOTE

Please read this manual and follow its instructions carefully. To emphasize special information, the symbol  and the words **WARNING**, **CAUTION** and **NOTE** have special meanings. Pay special attention to the messages highlighted by these signal words:

NOTE: *Indicates special information to make maintenance easier or instructions clear.*

 **WARNING**

Indicates potential hazard that could result in death or injury.

 **CAUTION**

Indicates potential hazard that could result in vehicle damage.

Table of Contents

Installation

Figure 1 Installation Diagram	Page 1
Required Hole size	Page 1
Small Connector	Page 1
Large Connector	Page 1
Installing the Fuel Flow Transducer	Page 2
Figure 2 Installation Guide (Fuel Flow Transducer)	Page 3

Operations

Lighting	Page 5
Tachometer	Page 5
Push Buttons	Page 5
Engine Running Only Hourmeter	Page 6
Fuel Level	Page 6
Other Features	Page 6
Fuel Management	
Fuel Flow	Page 6
Units per Hour selection	Page 6
Fuel Used	Page 7
Reset	Page 7
Calibrate	Page 7
Total Fuel Used	Page 7
Reset	Page 8
Fuel Remaining	Page 8
Adjust Fuel Remaining	Page 8
Fuel Remaining Alarm	Page 9
Figure 3 LCD Display Modes	Page 9

Warnings

Description	Page 10
Engine Temperature	Page 10
Rev Limit	Page 10
Oil Flow	Page 10
Check Engine	Page 10
Operating Modes	
Self Test	Page 10
Operating Mode	Page 10
Set-Up Mode	Page 10

Tachometer Selection	Page 12
Sender Selection	Page 14
Quick Reference Guide - Set-Up Mode	Page 14
Figure 4 Tachometer Set-Up	Page 14
Table 1 Tachometer Selection Table	Page 15
Table 2 Fuel Sender Selection Table	Page 15
Figure 5 Small Connector Plug Wire Diagram	Page 16
Figure 6 Large Connector Plug Wire Diagram	Page 17

(This page left blank intentionally.)

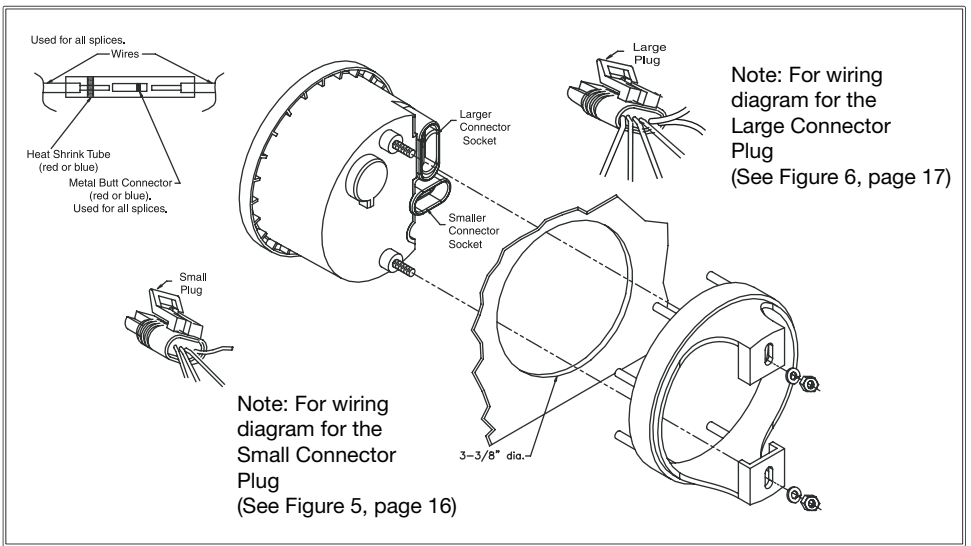

Figure 1

Use this manual for Commander™ Tachometer with hourmeter and fuel flow.

⚠ CAUTION

Disconnect the battery during installation. Tighten nuts on the backclamp only slightly more than you can tighten with your fingers. Six inch-pounds of torque are sufficient. Over-tightening could result in damage to the instrument and may void your warranty.

Tools Required

Ref. Tools Description

1. 3/8" Nut Driver
2. Suzuki Terminal Kit 09900-28701



(See Figure 6, Page 17)

Red Lens covers

Included with this instrument are 4 Red colored light bulb lens. These are used to change the color of the lights in the remaining instruments. (ex. Speedometer, Voltmeter, Trim Gauge, etc.)

Install the red lens covers on the bulbs of the other instruments.

Installation

1. Cut a 3-3/8" diameter hole in the dash for the 4" gauge. Mount the gauge with the backclamp supplied.
2. Small Connector Socket
Follow the wiring diagram at the end of this manual for connections. (See Figure 5, page 16)
3. Large Connector Socket
Follow the wiring diagram at the end of this manual for connections .

Installation Guide for the fuel flow transducer

CAUTION

A small amount of fuel may be released when the fuel feed hose is disconnected.

Place container under the fuel feed hose or 3-way joint pipe with a shop cloth so that released fuel is caught in container or absorbed in cloth. Place fuel soaked cloth in an approved container.

WARNING

Gasoline is extremely flammable and toxic. Always observe the following precautions when working around gasoline or servicing the fuel system.

- Disconnect battery cables except when battery power is required for servicing/inspection.
- Keep the working area well ventilated and away from open flame (such as gas heater) or sparks.
- Do not smoke or allow anyone else to smoke near the working areas.
Post a "NO SMOKING" sign.
- Keep a fully charged CO2 fire extinguisher readily available for use.
- Always use appropriate safety equipment and wear safety glasses when working around pressurized fuel system.
- To avoid potential fire hazards, do not allow fuel to spill on hot engine parts or on operating electrical components.
- Wipe up fuel spills immediately.

⚠ CAUTION

The fuel flow transducer should not be installed on the engine. Always install the Fuel Flow Transducer AFTER the primary filter. The Primary filter must be a good quality water separator type with a minimum filtration of 30 microns or better.

Damage due to insufficient filtration is not covered by warranty. If in doubt please consult your dealer for advice prior to installation.

Installation of the fuel flow transducer

The fuel flow transducer is designed for installation in Coast Guard approved $\frac{3}{8}$ " flexible fuel line. It should not be installed on the engine. The transducer MUST be installed AFTER the main fuel filter.

To install, drain all the fuel from the flexible fuel line. Cut the fuel line and, using the fuel hose attaching clips provided, install the transducer so that the FUEL IN side of the transducer is connected to the fuel line from the fuel tank.

It should be located well away from any area where it will be affected by excessive heat or vibration from the engine. It is preferable to mount the transducer in a vertical position.

Wiring Connection

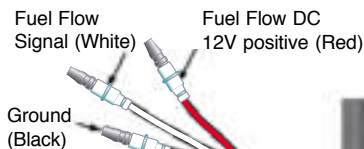

- Keep electrical and transducer cables away from alternator or other noise generating electrical cables.



From Tank

(This page left blank intentionally.)

Operation

Tachometer

The tachometer is a digital instrument with the appearance of an analog instrument. The tachometer is preset at the factory for a 6 pulse input. The setting for the tachometer can be changed in the Set-Up menu (Set-Up Mode page 10).

A microprocessor controlled stepper motor moves the pointer to display engine revolutions per minute using a linear dial.

The Commander™ has three push buttons: “Mode”, “Up”, and “Down”.

The “Mode” button is used to change the function of the LCD display and to access sub menus and adjustable settings.



The “Up” and “Down” buttons are used to modify the settings.

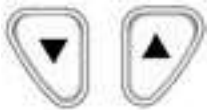

In normal operation mode, pressing the “Mode” button quickly causes the display to cycle between the different instrument displays. Pressing and holding the “Mode” button causes the display to change to the “settings” sub menu (see Figure 3, page 9).

When the settings menus have been selected, pressing the “Mode” button quickly causes the display to cycle through the setting options. Within each setting selection, pressing the “Up” and “Down” buttons causes the affected setting to change.

Note: The microprocessor will automatically record the new settings

as you adjust them.

When in a setting menu, pressing and holding the “Mode” button returns to the main function.



Lighting

In the normal operating mode the instrument lighting can be adjusted by pressing the “Up” and “Down” buttons.



The Tachometer and Fuel Level functions have several values that can be adjusted to match your installed equipment. These are changed in the Set-Up Mode. (See Figure 4, Table 1, and Table 2, page 14 & 15).

Use this option only if you have reason to believe that your settings are wrong. Setting an incorrect value in these menus can result in extremely inaccurate performance of the tachometer and fuel level sender.

Fuel Management Functions Description

The Commander™ Tachometer/ Fuel Monitor/ Engine Hourmeter combines the features of several instruments into one unit. The LCD displays the information for:

- 1) Engine Hours - Displays the number of hours the engine has been run.
- 2) Fuel Level - Displays fuel level in fuel tank (based on level sender) in percent.
- 3) Fuel Flow - Displays current fuel usage in Gallons or Liters per hour.
- 4) Fuel Used - Displays fuel used since last reset (trip fuel meter).
- 5) Total Fuel Used - Displays total fuel used since last reset (total fuel meter).

6) Fuel Remaining - Displays the fuel remaining since last set (based on fuel flow).

Engine Running Only Hourmeter

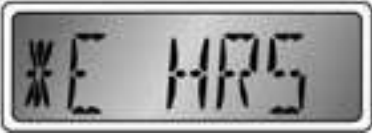

The Engine Hours display shows the number of hours the engine has been operated (Hr). The reading is based on a signal being received at the tachometer input to indicate that the engine is running. Units are displayed as:



Fuel Level



The Fuel Level display shows the amount of fuel in the fuel tank in percent of full (PC).



The indication is based on the fuel level sender in the tank and operates similarly to a normal fuel gauge. There are no adjustments to this reading.

Fuel Flow



The Fuel Flow display shows current fuel consumption in gallons per hour (GH) or

liters per hour (LH).

The fuel flow sensor can be calibrated if necessary using the Fuel Used "settings" menu (see Fuel Used description below). The units displayed may be changed using the submenu.

Pressing and holding the "Mode" button causes the display to change to the "UNITS" submenu (see Figure 3, page 9).



Fuel Flow "UNITS" Menu



Pressing the "Up" and "Down" buttons will change the setting between GH and LH.



Gallons per Hour (GH)



Liters per Hour (LH)



Fuel Used



The Fuel Used display shows the amount of fuel used since the gauge was reset. The display is based on the fuel flow system and therefore filling the fuel tank will not disturb the reading.

The Fuel Used display may be reset to zero and the Fuel Used and Fuel Flow system calibrated using the sub menus.



Pressing and holding the “Mode” button causes the display to change to the “settings” submenu (see Figure 3, page 9).



Fuel Used “Settings” Menu

There are two items in the Fuel Used “Settings” Menu; Reset and Fuel Calibration. Briefly pressing the “Mode” button cycles through the menu items.



The microprocessor will automatically record the new settings as you adjust them.

Reset



Pressing the “Up” and “Down” button resets the Fuel Used gauge to zero.



Calibration



If you know “exactly” how much fuel you have used since the Fuel Used gauge was reset you can adjust the amount and, therefore, the Fuel Flow sensor calibration in this “setting” menu.

Pressing the “Up” or “Down” buttons changes the “amount of fuel used” display.



When the displayed quantity matches the amount of fuel you know you have used, calibration is complete.

Total Fuel Used



The Total Fuel Used display shows the amount of fuel used since the Total Fuel Used gauge was reset.

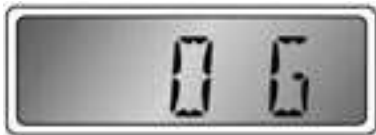

This gauge is useful for keeping track of fuel usage over a longer period of time or distance than the Fuel Used gauge. The display is based on the fuel flow system and therefore filling the fuel tank

will not disturb the reading. The Total Fuel Used gauge may be reset to zero using the submenu.

Pressing and holding the “Mode” button causes the display to change to the “settings” submenu (see Figure 3, page 9).



Total Fuel Used “Settings” Menu

There is one item in the Fuel Used “Settings” Menu; Reset.

Reset



Pressing the “Up” or “Down” button resets the Total Fuel Used gauge to zero.



Fuel Remaining



The Fuel Remaining display shows the amount of fuel remaining in G or L.



This display is based on your manually entered information (see Adjust Fuel Remaining below) and the accumulated Fuel Flow data since the gauge was adjusted. This information is not

obtained from the fuel sender in the fuel tank and therefore is not affected by the boat position or angle as the fuel sender may be.

There is an alarm which may be set to warn of a low fuel condition. The amount of Fuel Remaining and the Fuel Remaining Alarm may be adjusted using the submenu.

Pressing and holding the “Mode” button causes the display to change to the “settings” submenu (see Figure 3, page 9).



Fuel Remaining “Settings” Menu

There are two items in the Fuel Remaining “Settings” Menu; Adjust Fuel Remaining and Fuel Remaining Alarm.

Briefly pressing the “Mode” button cycles through the menu items.



The microprocessor will automatically record the new settings as you adjust them.

Adjust Fuel Remaining



When you fill the fuel tank or add fuel, you make a reasonable (or “exact”) estimate of the amount of fuel you have. Using this menu item you can enter (adjust) the amount of fuel remaining to your known (or estimated) amount.

Pressing the “Up” or “Down” buttons will change the indicated Fuel Remaining.

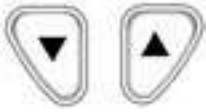

Fuel Remaining Alarm



This alarm may be set to warn you when there is only a certain amount of fuel remaining according to the Fuel Flow usage calculation.

Pressing the “Up” or “Down” buttons will change the Fuel Remaining Alarm setting.



Quick Reference Guide

Fuel Management LCD Display Modes

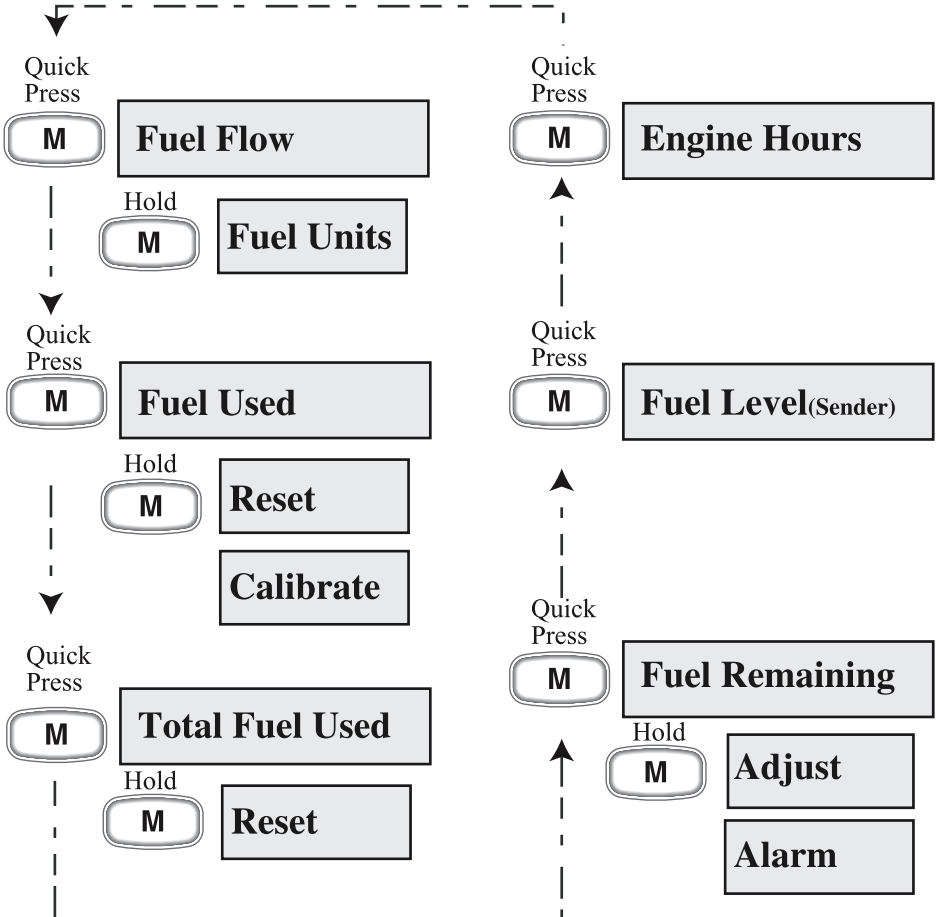

Figure 3

Suzuki® Warnings

Description

Suzuki Warning Monitor Function Is a system that monitors all critical engine functions including engine temperature, over-rev protection, oil pressure & check engine diagnostics.

This information is displayed on the digital LCD screen of your Commander Series Instruments.

Information about the wiring to the Suzuki® harness can be found at the end of this manual. (See Figure 5, 990C0-86036, page 16.

Engine Temperature:

The displayed warning is “OVR TMP”.



Rev Limit:

A signal from the engine ECU causes this warning indicating an over rev limit has been reached.

The displayed warning is “REV LIM”.



Oil Pressure:

Four stroke engine: An oil pressure switch is used.

The warning will be displayed as “NO OIL”.



Check Engine:



If a check engine warning is displayed when the engine is running, the words “CHK ENG” will be indicated on the LCD screen. You must stop the engine to retrieve the “flash” code that designates which problem has occurred. You must return to engine idle speed and either pull the emergency stop switch to stop the engine (but leave the ignition key in the on position) or turn the key switch off to stop the engine, then turn it back on (do not restart the engine).

With the engine not running and the key in the “ON” position, the words “CHK ENG” will flash the current diagnostic codes(s). A diagnostic code of 2-4 will consist of 2 “CHK ENG” flashes with a pause and then 4 “CHK ENG” flashes with a slightly longer pause.

Operating Mode:

On power up (key on), a limited self-test is performed to inform the operator that the system is active. The test activates the audible alarm and all warning messages. During the self test, the audible alarm sounds for 1/4 second.

At the same time, the unit begins displaying all of the warning messages. Each warning message is displayed for 1 second. When all four messages have been displayed, the self test is complete.

Setup Mode

Description

The Tachometer and Fuel Level functions have several values that can be adjusted to match your installed equipment. These are changed in the Set-Up Mode (see Set-Up Menu guide below).

Tachometer settings and the fuel level

sender type can be changed using the Setup Mode (see Figure 4, Table 1, and Table 2 page 14 & 15).

Use this option only if you have reason to believe that your settings are wrong. Setting an incorrect value in these menus can result in extremely inaccurate performance of the tachometer and fuel level sender.

To access the Setup Mode, press and hold both the “Up” and “Down” buttons while turning on the key.



The display will show,



Briefly pressing the “Mode” button will

cycle through the menu items.



The “Up” and “Down” buttons are used to modify the settings.



The microprocessor will automatically record the new settings as you change them.

Pressing and holding the “Mode” button sets the instrument to normal operation.



Tachometer Selection

Refer to Figure 4 (page 14) and Table 1 for an explanation of each of the tachometer selections.

T SCALE-

The “TAC 4” - “TAC 5” settings are normal engine tachometer settings based on different engine options found on most boats.

Using “Up” and “Down” buttons, adjust the setting to match the engine in the boat as shown in Figure 4 (page 14).

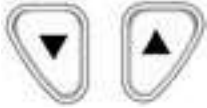

The “TEETH” submenu is NOT USED.



The “TAC 9VA” setting is NOT USED.



Sender Selection

Allows you to set the type of Fuel Level sender installed in the fuel tank. See Figure 4, Table 2 (page 14 & 15).

Set up is now complete.

(This page left blank intentionally.)

Tachometer Full Scale Selection

Refer to Figure 4 for an explanation of each of the tachometer full scale selections.

This is normally a factory setting that needs no adjustment. The setting adjusts the “full scale” operating range of the tachometer to match the dial on the instrument. Using the “Up” and “Down” buttons, adjust the setting to match the maximum reading on the tachometer dial, 4000, 6000, or 7000 RPM.

Fuel Level Sender Selection

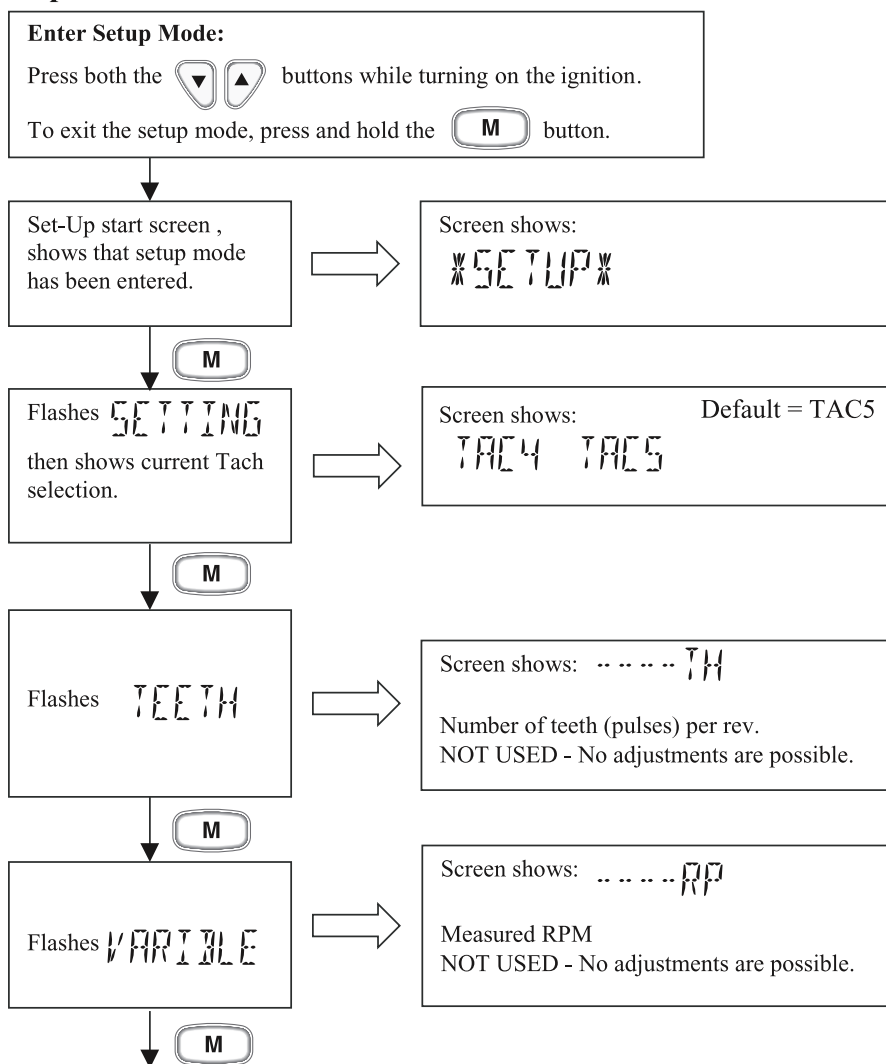

Refer to Figure 4 and Table 2 for an explanation of each of the fuel level sender selections. Using the “Up” and “Down” buttons, adjust the setting to match the fuel level sender installed in the fuel tank.

Figure 4 Quick Reference Guide Set-Up Mode



Flashes **SCALE**
then shows current
tachometer scale
selection.



Screen shows: **Default = 7K**
4K 6K 7K
  **adjusts Tachometer full scale
reading to match dial.**



Flashes **SENDER**
then shows current fuel
sender selection.





Screen shows: **Default = US**
US EU
  **changes sensor selection**

Table 1
Tachometer Selection Table

TAC 4	Five pulses per rev. (10 pole alternator on outboard engine)
TAC 5	Six pulses per rev. (12 pole alternator on outboard engine)

Table 2
Fuel Sender Selection Table

US	Standard United States fuel sender (240 – 33 Ohms)
EU	Standard European fuel sender (10 – 180 Ohms)

to Commander

Figure 5 4 - pin connector Small Connector p/n 990C0-86036

4- pin connector(CN0082)

Pin A	Gray	+14 VDC Ignition
Pin B	Green/White	Check Engine
Pin C	Black	Ground
Pin D	Yellow	Signal

HN0394 ECR 6988 11/14/07

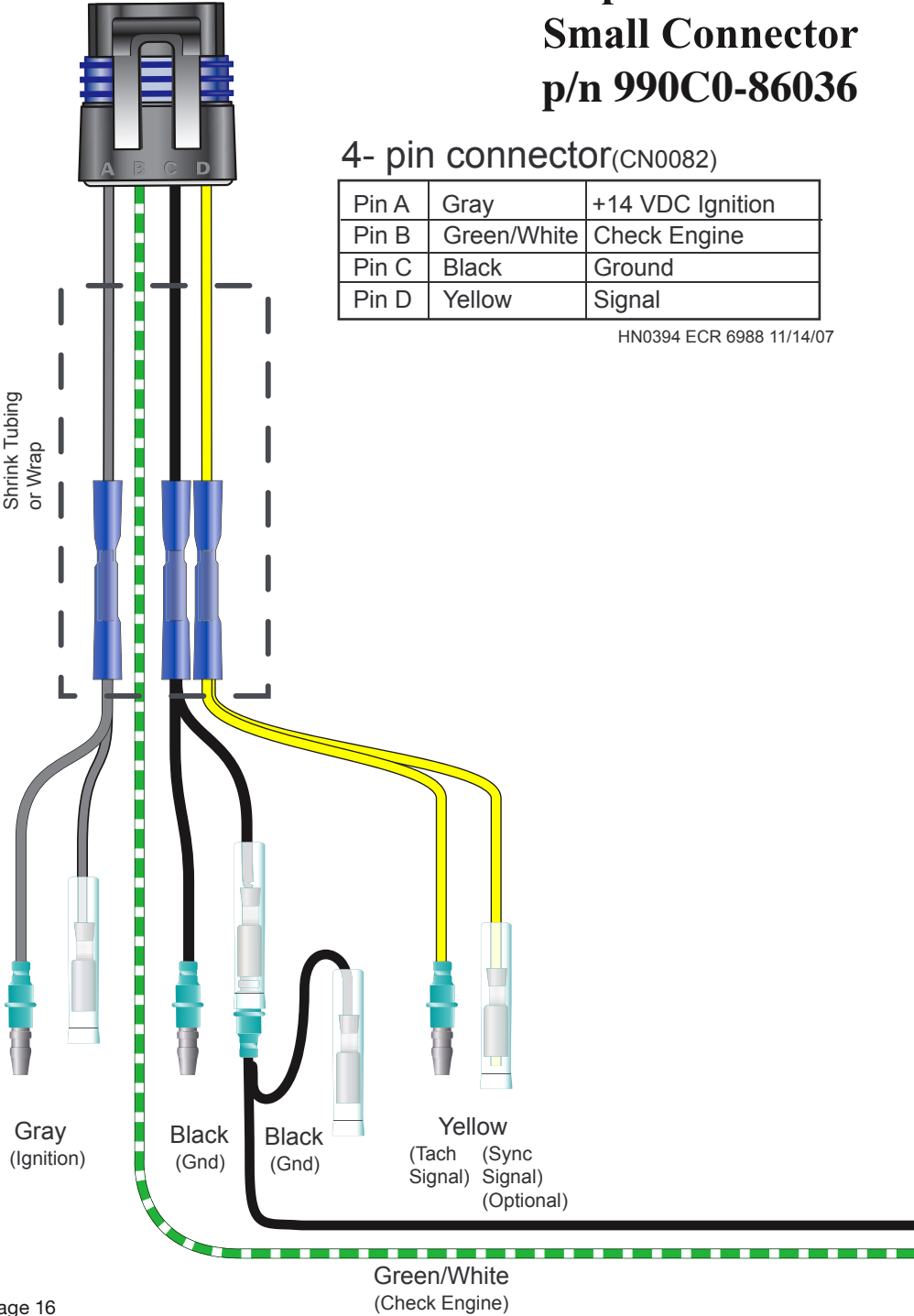

to Commander

Figure 6

6 - pin connector

Large Connector

p/n 990C0-86036

6- pin connector (CN0083)

Pin A	Red	Fuel Flow Trans Power
Pin B	Green/Yellow	Over Temperature
Pin C	White	Fuel Flow Trans Signal
Pin D	Pink/Black	Fuel Tank Level
Pin E	Pink	Rev Limit
Pin F	Blue/Black	"NO OIL" Sensor

HN0394 ECR 6988 11/14/07

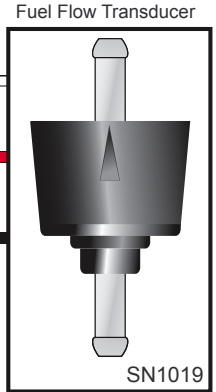
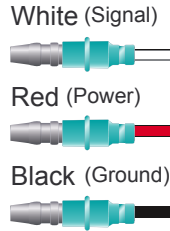
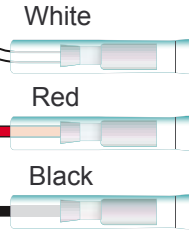
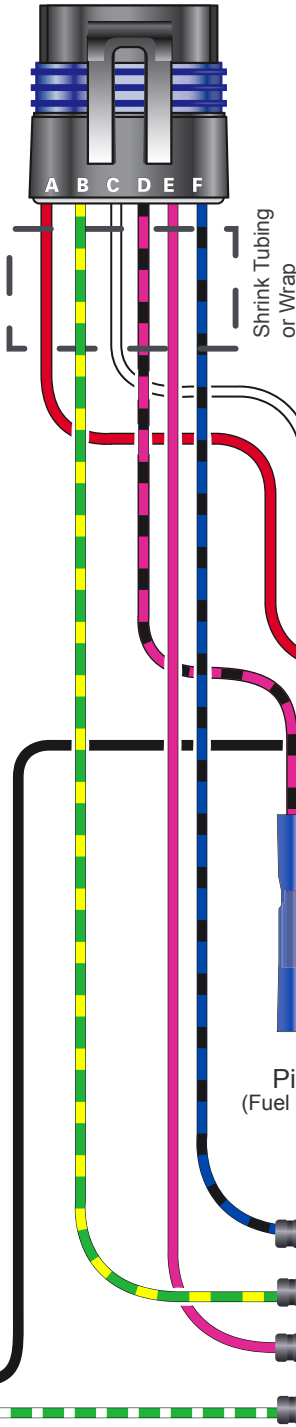

Pink/Black
(Fuel Level)

Socket Connector (CN0107)

Socket 1	Green/White	Chk Engine
Socket 2	Pink	Rev Limit
Socket 3	Green/Yellow	Over Temp
Socket 4	Blue/Black	Oil Press

ECR 4362 2/13/04

- 4 Blue/Black (Oil Press)
- 3 Green/Yellow (Over Temp)
- 2 Pink (Rev Limit)
- 1 Green/White (Check Engine)

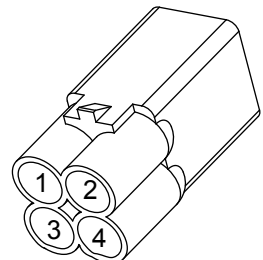

Notes:

Copyright 2007 by the Thomas G. Faria Corporation, Uncasville CT
No part of this publication may be reproduced in any form, in an electronic retrieval system or otherwise, without the prior written permission of the company.
Suzuki® is the trademark of the Suzuki Motor Corporation