

Copyright 2005 by the Thomas G. Faria Corporation, Uncasville CT

No part of this publication may be reproduced in any form, in an electronic retrieval system or otherwise, without the prior written permission of the company.

Faria® is the trademark of the Thomas G. Faria Corporation

Faria[®]

**MARINE
INSTRUMENTS**

Owners's Manual



Pilot II Tachometer

ISO153
rev.C ECR 4852 8/2004

Index

Description	
Key Pad Functions	Page 1
Set- Up Mode	Page 2
Operations	
Power On	Page 3
Illumination	Page 3
Normal Mode	Page 3
Select Mode	
Activating	Page 3
Selecting upper or lower display	Page 3
Selecting display function	Page 3
Edit Mode	Page 4
Choosing the Edit Mode	Page 4
<i>Upper Display Functions</i>	Page 4
Tachometer	
Description/ Operation	Page 5
Setting Alarm	Page 5
Engine Temperature	
Operation	Page 5
Setting Engine Temperature Units	Page 6
Oil Pressure	
Description/ Operation	Page 6
Setting the Oil Pressure alarm	Page 6
Setting the Oil Pressure units	Page 6
<i>Lower Display Functions</i>	Page 7
Fuel Flow	
Description/ Operation	Page 7
Setting the Fuel Flow Units	Page 7
Fuel Used	
Description/ Operation	Page 7
Resetting the Fuel Used Value	Page 8
Calibrating the Fuel Management System	Page 8
Total Fuel Used	
Operation	Page 9
Resetting the Total Fuel Used Value	Page 9
Fuel Remaining in Tank	
Description/ Operation	Page 9
Adjust Fuel Remaining in Tank Value	Page 10
Setting Fuel Remaining in Tank Alarm	Page 10
Engine Running Hourmeter	
Description	Page 10
Operation	Page 11

Bar Graph Functions	Page 11
Fuel Level	
Description/ Operation	Page 11
Trim Adjustment	
Description/ Operation	Page 11
YAMAHA Special Functions	
Oil	Page 13
2 Stroke Yamaha Engines	Page 13
4 Stoke Yamaha Engines	Page 13
Temperature	Page 13
2 and 4 Stroke Yamaha Engines	Page 13
Set-Up Mode	Page 16
Yamaha Mode	Page 17
Others Mode	Page 18
HN0363 - Yamaha Adapter Harness Addendum A	Page 21
HN0366 - Others Adapter Harness Addendum B	Page 23
HN0374 - Honda Adapter Harness Addendum C	Page 25

Key Pad Functions Display

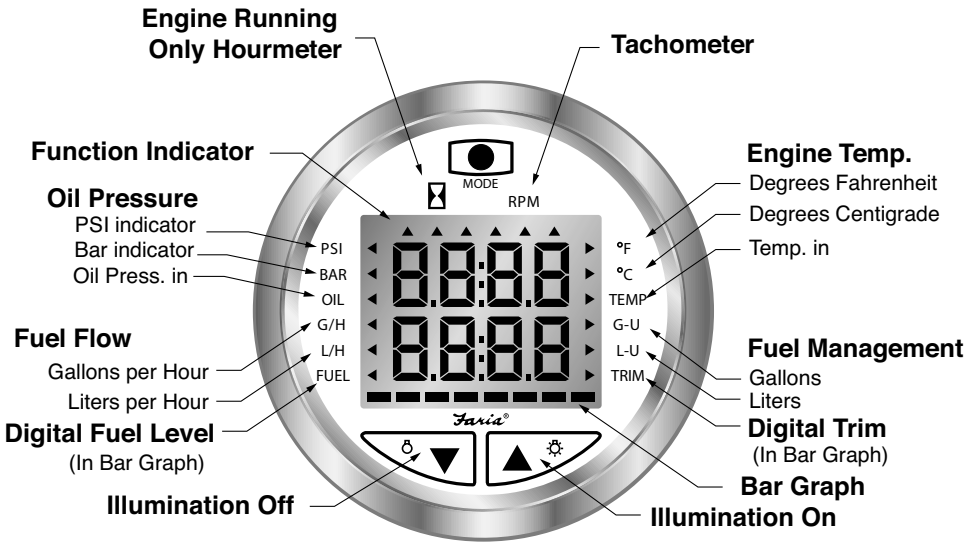

Faria Pilot II Description

The Faria Pilot II system is a multifunctional instrument designed to give simultaneous readouts of several different and independent functions on an upper and lower LCD display. A digital Bar Graph provides continuous display of either Trim or Fuel Level. The illustration above shows the various functions provided by the instrument.

Warning: The Fuel Management system is not to be used for navigation.

Important: Always install the Fuel Flow Transducer AFTER the primary filter. The primary filter must be a good quality water separator type with a minimum filtration of 30 microns or better. Failure to provide this level of filtration protection will result in inaccurate readings or total failure or damaged to the transducer. If there is not a suitable length of hose after the primary filter, an in-line filter (30 micron or better) should be fitted before the Fuel Flow transducer. Damage due to insufficient filtration is not covered by warranty. If in doubt please consult you local Faria® Marine Instruments dealer for advice prior to installation.

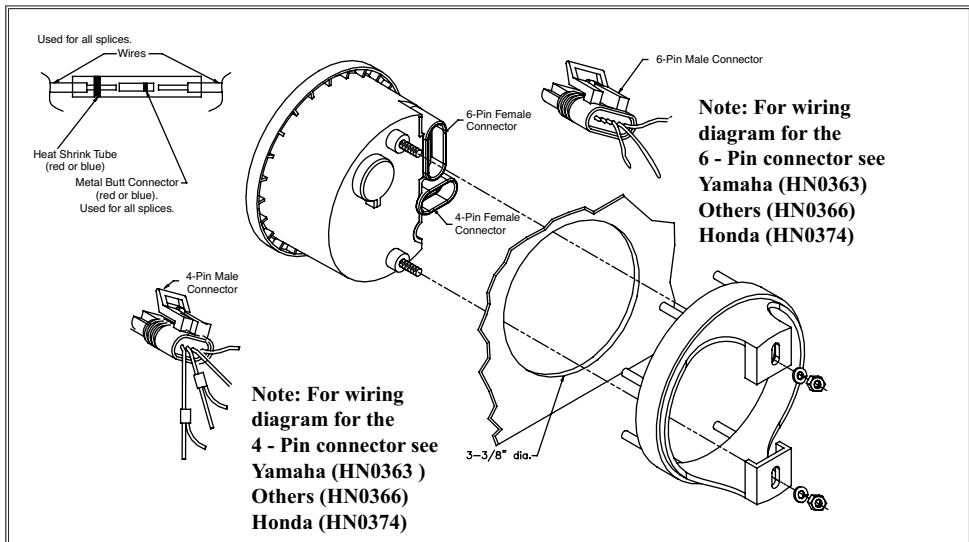

Set-Up Mode:

The Set-Up Mode allows the operator to adjust the operation of the Pilot II to many operating conditions and installed options on the boat. "Set-Up" Mode is often only used once and therefore requires a special method to access the settings. To access "Set-Up" Mode, press and hold both the "Up" and "Down" buttons while turning on the ignition switch.



Press the "Mode" button to advance through the menu selections.



Once any changes have been made to the various settings, the "Mode" button must be pressed and held. This will save all settings and cause the Pilot II to enter Operation mode.

Pilot II has two main modes of operation, YAMAHA and OTHER. Yamaha mode is designed to utilize the various automatic features of the 2001+ Yamaha outboard

engine. "Other" mode can accommodate many different features of several types of installations.

The first menu that appears in Set-Up mode is the selection of one of these two modes of operation, displayed as "YAHA" and "OtHr". The default is "OtHr"



For more set-up procedures including set up of the trim function see the Set-up Mode procedures later in this manual.

Operation

Power:

The Pilot II instrument will turn on when the ignition key switch is set to the run position. When the ignition key switch is turned to the off position, the Pilot II will turn off.

*If the mode button is accidentally pressed for an extended period of time the unit will enter a diagnostic OFF Mode. This can be remedied by pressing the "Mode" button again to turn the unit on

Illumination On or Up:

To turn the dial illumination on or make it brighter, press the right, "Up" arrow with the Pilot II in the "Normal" mode.



Illumination Down or Off:

To turn the dial illumination down or off, press the left, "Down" arrow with the Pilot II in the "Normal" mode.



"Normal" Mode:

Pilot II is operating showing the last selected functions. "Normal" Mode functions available are:

Upper Digital Display:

Tachometer

Engine Temperature

Oil Pressure

Lower Digital Display:

Fuel Flow

Fuel Used

Total Fuel Used

Fuel Remaining in Tank

Engine Running Hourmeter

Bar graph Display:

Fuel Level

Trim Adjustment

Note: When in either the "Select" or "Edit" Modes described below, **if no button is pushed for 5 seconds the Pilot II will revert to the "Normal" Mode** displaying the functions last used or the new values if settings have been changed.

"Select" Mode:

The "Select" Mode allows selection of the upper, lower, or bar graph LCD displays and / or the function desired in each display.

Activating the "Select" Mode:

To activate the "Select" Mode, press the "Mode" button quickly. The Pilot II will beep and the last selected active display (upper, lower or bar graph) will flash.



Selecting the upper, lower, or bar graph active display:

Activate the "Select" Mode and **while the display is flashing**, press the "Up" or "Down" arrow to select the desired active display.



Selecting a display function, (moving the Function Indicator):

When in the "Select" Mode (with the display flashing), press the "Mode" button quickly.



With each press of the "Mode" button the

display will show new information. The Function Indicator(s) at the edges of the display will show which function is being displayed and in many cases, the display units.

For example, when the Function Indicator next to TEMP is active, either the °F or °C indicator will also be active. The Pilot II will beep each time the “Mode” button is pressed. Stop at the desired function.

“Edit” Mode:

The “Edit” Mode allows you to adjust or set the values for the following features of the Pilot II:

Upper Digital Display:

Tachometer: Over-rev alarm.

Engine Temperature: Engine over temp alarm, and temperature units (°F or °C).

Oil Pressure: Low oil pressure alarm, and oil pressure units (PSI or BAR).

Lower Digital Display:

Fuel Flow: Fuel units (G or L)

Fuel Used: Reset fuel used, and calibrate fuel flow system.

Total Fuel Used: Reset total fuel consumed

Fuel Remaining in Tank: Adjust fuel remaining in tank, and set fuel remaining in tank alarm.

Engine Running Hourmeter: No settings.

Bar graph Display:

Fuel Level: No settings

Trim Adjustment: No settings (See the “Set Up” Mode to adjust the full up and full down calibration limits for your trim sender. The “Set Up” Mode limit calibration must be done to ensure the most accurate use of your trim adjusts display. This calibration need only be done once unless the engine mount or

the trim sender are moved, in which case, the limit calibration must be repeated.)

Choosing the “Edit” Mode:

Select the desired display function. Press and hold the “Mode” button until the Pilot II beeps.



The “Edit” Mode is now active. If no buttons are pushed within 5 seconds, the Pilot II will revert automatically to the “Normal” Mode.

You can also enter the “Edit” Mode while in the “Select” Mode. The Pilot II display will then stop flashing (“Select” Mode) indicating the change to the “Edit” Mode. Changes that are made in the “Edit” Mode are saved as they are made.

To exit the “Edit” Mode, press and hold the “Mode” button.

If no button is pressed for five seconds, the unit will automatically exit the “Edit” Mode.

The operation of the “Edit” Mode will be explained for each function throughout this manual.

Upper Digital Display Functions

The upper digital displays utilize the TEMP, BF, BC; OIL, PSI, BAR; and the RPM Function Indicators.



Tachometer:

Description:

The Tachometer function provides a digital LCD display of engine RPM from 0 to 9995 RPM. In order to minimize “flicker”, RPM is displayed in 5 RPM increments.

The function includes a user adjustable “over rev” alarm. When the engines RPMs exceed the alarm setting the tachometer display flashes and an audible alarm is activated. The alarm remains active until the “over-rev” condition is corrected. The alarm setting is adjustable in 100 RPM increments from 0 to 9900 RPM. The alarm setting, once made, is stored in memory and will remain even if the battery is disconnected. The alarm can be completely disabled by setting the alarm RPMs to a higher value than the engine can achieve or by setting the alarm value to off.

Operation

Using “Select” Mode, change upper display screens until the Function Indicator is pointing to RPM. The LCD is now displaying engine RPM.



Setting the Alarm

Press and hold the “Mode” button until the Pilot II beeps. The unit is now in “Edit” Mode.



The current setting for the “over-rev” setting will be displayed. Using the “Up and Down” buttons, adjust the setting to the desired RPM.



Engine Temperature

(For operation of the Temperature Function in Yamaha Mode see below.)

Description:

The Engine Temperature function provides a digital LCD display of engine temperature. Engine Temperature is displayed in 2° F or 1° C increments. Fahrenheit or Celsius units can be selected for the Engine Temperature function. A user adjustable “over-temp” alarm is also provided. The alarm provides a visual and audible indication that the Engine Temperature has exceeded the preset alarm value.

Operation

Using “Select” Mode, change upper display screens until the Function Indicator is pointing to TEMP. An additional Function Indicator will turn on pointing to either °F or °C. The LCD is now displaying Engine Temperature in the indicated units.

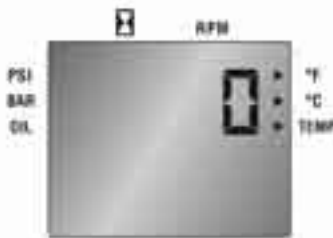

Setting the Engine Temperature Alarm

Press and hold the “Mode” button until the Pilot II beeps.



The unit is now in “Edit” Mode. The current setting for the “over-temp” value will be displayed. Using the “Up” and “Down” buttons, this value can be adjusted to the desired setting.



Setting the Engine Temperature Units

Pressing the “Mode” button again in the “Edit” mode will change the display to show the current temperature units selected.



Using the “Up” and “Down” buttons, the units can be changed between °F and °C.



Oil Pressure:

(For operation of the Oil Level Function in Yamaha Mode see below)

Description:

The Oil Pressure function provides a digital LCD display of engine oil pressure. Oil pressure is displayed in 2 PSI increments. PSI or BAR units can be selected for the Oil Pressure function. A user adjustable “low oil pressure” alarm is also provided. The alarm provides a visual and audible indication that the oil pressure is less than the preset alarm value.

Operation

Using “Select” Mode, change upper display screens until the Function Indicator is pointing to OIL. An additional Function Indicator will turn on pointing to either PSI or BAR. The LCD is now displaying Oil Pressure in the indicated units.

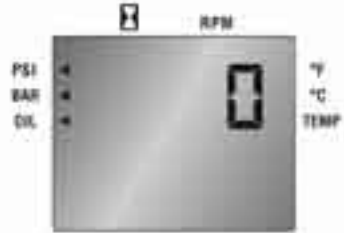

Setting the Oil Pressure Alarm

Press and hold the “Mode” button until the Pilot II beeps.



The unit is now in “Edit” Mode. The current setting for the “low oil pressure” value will be displayed. Using the “Up” and “Down” buttons, this value can be adjusted to the desired setting.



Setting the Oil Pressure Units

Pressing the “Mode” button again in the



“Edit” mode will change the display to show the current pressure units selected.



Using the “Up and Down” buttons, the units can be changed between PSI and BAR.

Lower Digital Display Functions

The lower digital displays utilize the G/H, L/H; G-U, L-U; and the “hourglass” Function Indicators.



Fuel Management System

Fuel Flow:

Description

The Fuel Flow function provides a digital LCD display of the current fuel consumption rate. Fuel Flow is displayed from 0.5 – 35 GPH in 0.1 increments. Gallons or Liter can be chosen as the unit of measure for the Fuel Flow function.

Operation

Using “Select” Mode, change lower display screens until the Function Indicator is pointing to G/H or L/H. The LCD is now displaying Fuel Flow in the indicated units.

Setting the Fuel Flow Units

Press and hold the “Mode” button until the Pilot II beeps. The unit is now in “Edit” Mode.



The current setting for the fuel units, G/H or L/H, will be displayed. Using the “Up”

and “Down” buttons, this value can be changed to the desired setting.



When this choice is made, all values in the Fuel Management System are correctly converted to the new units. This includes stored and accumulated values.

Fuel Used:

Description

The Fuel Used function displays the amount of fuel used, from 0.1 to 999.9 gallons or corresponding liters since this function was last reset. This function is similar to a trip odometer and can be used in a similar fashion. The value displayed can be reset to zero in the “Edit” Mode and will then log the quantity of fuel used since the reset. A second “Edit” Mode display allows calibration of the Fuel Management System system (see below).

Operation

Using “Select” Mode, press the “Mode” button once from the Fuel Flow function to access the Fuel Used function. The Function Indicator will point to G-U or L-U and the display will indicate XXX.X (with decimal point). The LCD is now displaying Fuel Used in the indicated units.

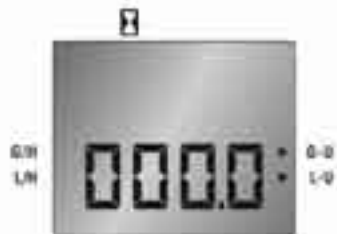

Resetting the Fuel Used Value

Press and hold the “Mode” button until

the Pilot II beeps.



The unit is now in “Edit” Mode. The current quantity of fuel used since last reset is displayed. Pressing the “Up” or “Down” arrow button will reset the quantity displayed to zero.



Calibrating the Fuel Management System

Calibration of the Fuel Management System is accomplished by comparing and correcting the Fuel Used reading to a known amount of fuel replaced.

The procedure is as follows:

- 1) The Fuel Used function is reset to zero when the fuel tank is filled.
- 2) The engine is operated until as much fuel as possible is consumed. The amount is not critical but the more fuel that is used, the better the calibration.
- 3) The fuel tank is refilled and the amount of fuel added by the refueling pump is noted.
- 4) The amount of fuel indicated by the Fuel Used display is adjusted to match the amount of fuel added.
- 5) The adjusted “fuel used” value is used by the microprocessor to correct all stored and active fuel values and calculations. Once this has been done, the measured and displayed values in the Fuel Management System will reflect this calibration until repeating this procedure changes the calibration.

Enter the “Edit” Mode.

Do Not Reset The Fuel Used Display.

Press the “Mode” button again in the “Edit” Mode and the unit will be in the Fuel Cal mode.



The display will continue to show the last Fuel Used value. Using the “Up” and “Down” arrow buttons, adjust the value displayed to match the amount indicated on the refueling pump.



Press and hold the “Mode” button to exit “Edit” Mode.



Now reset the Fuel Used value to zero using the procedure above. The fuel management system is calibrated. It is strongly recommended that this procedure be accomplished prior to utilizing the information from the “Fuel Remaining in Tank” function below.

Total Fuel Used:

Description

The Total Fuel Used function displays the amount of fuel used, from 0 to 9999 gallons or corresponding liters since this function was last reset. Uses for this function might include accumulating the fuel used during several short “trips” or legs of a longer trip. It could also be used

to accumulate the fuel used over a longer time frame to more effectively monitor fuel usage. The value displayed can be reset to zero in the “Edit” Mode and will then log the quantity of fuel used since the reset.

Operation

Using “Select” Mode, press the “Mode” button once from the Fuel Used function to access the Total Fuel Used function.



The Function Indicator will point to G-U or L-U and the display will indicate XXXX (with no decimal point). The LCD is now displaying Total Fuel Used in the indicated units.



Resetting the Total Fuel Used Value

Press and hold the “Mode” button until the Pilot II beeps.



The unit is now in “Edit” Mode. The current total fuel used quantity is displayed. Pressing the “Up” or “Down” arrow button will reset the quantity displayed to zero.



Fuel Remaining in Tank:

Description

This function displays the amount of Fuel Remaining in Tank from 0 – 999.9 gallons or corresponding liters since this function was last reset. It operates similarly to the “Normal” fuel level gauge but is based on information manually entered by the operator and the Fuel Used data from the Fuel Management System to calculate the amount of fuel that should be remaining in the tank. This function is NOT a substitute for the fuel level gauge but can be used to provide a secondary source of fuel level information. In addition, a user adjustable alarm can provide an audible and visual indication that the fuel level is below the preset alarm level.

Operation

Using “Select” Mode, press the “Mode” button once from the Total Fuel Used function to access the Fuel Remaining in Tank function.



The Function Indicator will point to G-U or L-U and the display will indicate XXX.X (with decimal point). The LCD is now displaying Fuel Remaining in Tank in the indicated units.

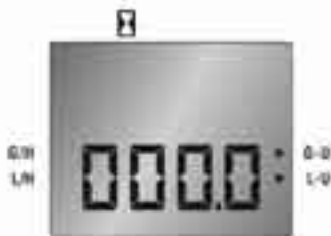

To use this function, the “known” amount of fuel in a full fuel tank is manually entered by the user. As with the calibration procedure, this is best done

when the fuel tank is filled at the refueling pump. Once the tank is known to be full, the displayed value of Fuel Remaining in Tank must be manually set by the operator to match the known capacity of the fuel tank. The Fuel Used value is then continuously subtracted from the full tank, “at the pump”, value to provide the Fuel Remaining in Tank quantity.

Adjust Fuel Remaining in Tank Value

Press and hold the “Mode” button until the Pilot II beeps.



The unit is now in “Edit” Mode. The current fuel remaining in tank quantity is displayed and the indicator blinks indicating either G-U or L-U, which ever is selected.



Pressing the “Up” or “Down” arrow buttons will adjust the indicated value, in steps of .2 gal/liters, to match the known full fuel tank capacity.



It is strongly recommended that the Fuel Management System calibration procedure above be accomplished prior to utilizing the information from the “Fuel Remaining in Tank” function.

Setting Fuel Remaining in Tank Alarm

Press the “Mode” button again in the “Edit” mode to change the display to show the current Fuel Remaining in Tank Alarm value.



Using the “Up” and “Down” buttons, the value can be changed, in whole gal/liters steps, to the desired number of gallons of fuel remaining below which the alarm will activate.



The new value is automatically saved. Press and hold the “Mode” button to exit the “Edit” mode.



Engine Running Hourmeter:

Description

The Engine Running Hourmeter function displays the number of hours that the engine has been operated. The hours are only counted when a tachometer signal is received. The hours displayed therefore reflect true hours of engine use. The hourmeter displays 0.1 to 999.9 hours. No reset is available.

Operation

Using “Select” Mode, change lower display screens until the Function Indicator is pointing to the “hourglass” symbol. The LCD is now displaying Engine Running hours.

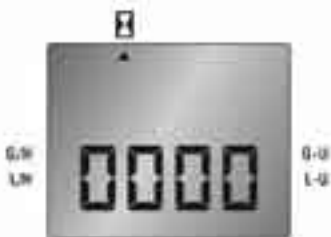

Bar Graph Display Functions

The bar graph displays utilize the FUEL and TRIM Function Indicators.

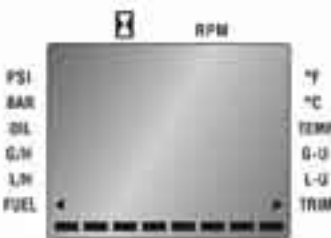

Fuel Level

Description

The Fuel Level bar graph displays the amount of fuel in the fuel tank. The information for this display is obtained from the fuel level sender mounted in the fuel tank. A full fuel tank is displayed as all segments of the display activated.

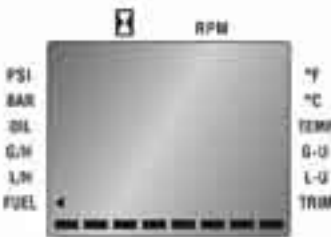

A fuel tank approaching empty is displayed as only one segment active.



This function provides a continuous monitor of fuel level. Used in conjunction with the calibrated Fuel Remaining in Tank function and alarm, very accurate monitoring of fuel level can be obtained.

NOTE: For proper operation no additional fuel gauge may be connected to the fuel level sender.

Operation

Using “Select” Mode, change the bar graph screens until the Function Indicator is pointing to FUEL. The LCD is now displaying Fuel Level in 8ths of a tank.

Trim Adjustment

Description

The Trim Adjustment bar graph displays the current position of the engine trim sender. This display can be used to establish “reference” settings for trim adjustment. Small adjustments can then be made to optimize the trim setting. The Trim limit adjustment in the Set Up mode should be performed to correctly set the limits of the trim sender in the actual installation.

Operation

Using “Select” Mode, change bar graph screens until the Function Indicator is pointing to TRIM. The LCD is now displaying the current Trim Adjustment setting.



YAMAHA Special Functions:

Oil:

In “Yamaha” Mode Pilot II provides standard Yamaha oil level information in lieu of oil pressure readings when the Oil Function is selected or whenever a Yamaha warning condition exists.



2 Stroke Yamaha Engines

- 1) When all oil levels are satisfactory the Oil Function displays “GOOD”



- 2) When the main oil tank is empty but the reserve oil tank is satisfactory the Upper Display changes to the Oil Function and displays “rES”. The display flashes slowly and the audible alarm sounds to warn the operator that oil is needed very soon.



- 3) When the main oil tank still contains oil but the reserve oil tank is approaching empty, the Upper Display changes to the Oil Function and displays “rES0”. The display flashes quickly and the audible alarm sounds rapidly to warn the operator that while there is oil in the main tank, the engine reserve tank is almost empty.

- 4) When both the main oil tank is empty and the reserve oil tank is approaching empty, the Upper Display changes to the Oil Function and displays “OIL”. The display flashes quickly and the audible alarm sounds rapidly to warn the operator that all oil is almost depleted.

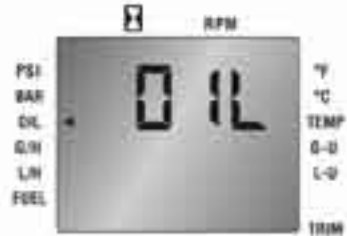

4 Stroke Yamaha Engines

When the oil pressure drops below safe levels the Upper Display changes to the Oil Function and displays “OIL”. The display flashes quickly and the audible alarm sounds rapidly to warn the operator that oil pressure is too low.

Temperature:

In Yamaha mode Pilot II provides standard Yamaha over-temperature warnings in lieu of engine temperature readings when the Temperature Function whenever a Yamaha warning condition exists.

2 and 4 Stroke Yamaha Engines

When the engine temperature exceeds acceptable limits, the Upper Display

changes to the Temperature Function and displays “HOt” The display flashes slowly and the audible alarm sounds to warn the operator that engine temperature is too high.



The Set-Up Mode

The Set-Up Mode allows the operator to adjust the operation of the Pilot II to many operating conditions and installed options on the boat.

Set-Up Mode is often only used once and therefore requires a special method to access the settings. **To access Set-Up Mode, press and hold both the “Up” and “Down” buttons while turning on the ignition switch.**



Press the “Mode” button to advance through the menu selections.



Once any changes have been made to the various settings, the “Mode” button must be pressed and held. This will save all settings and cause the Pilot II to enter **Operation Mode**.

Pilot II has two main modes of operation, Yamaha and Other. Yamaha mode is designed to utilize the various automatic features of the 2001+ Yamaha outboard engine. The “Other” mode can accommodate many different features of several types of installations.

The first menu that appears in Set-Up mode is the selection of one of these two modes of operation, displayed as YAHA and Othr.

The default is Othr.

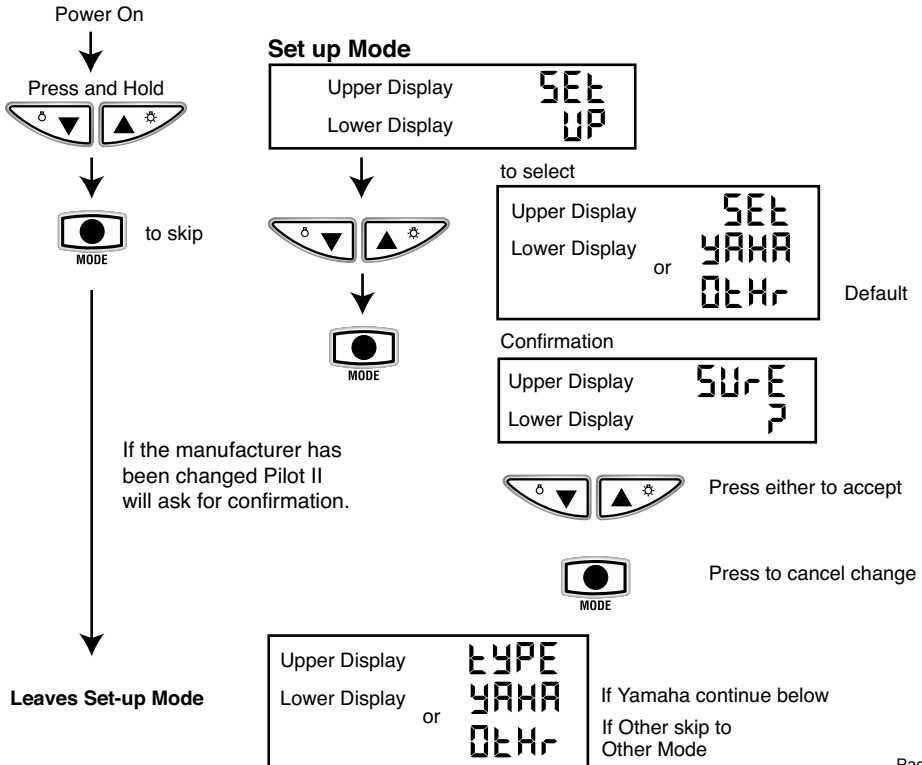

Yamaha Mode

Note: Please refer to owners manual for proper settings.

Yamaha Mode

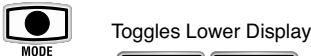

Toggles Lower Display



2 or 4 Stroke Engine

Toggles Lower Display



6 or 12 Pole Tach.

Toggles Lower Display



Signal Level

The default values are usually correct but can be changed if needed

Toggles Lower Display



Trim Sensor Limits

Used to calibrate the trim display to the actual installation.

Toggles Lower Display



Trim Sensor Limits

Used to calibrate the trim display to the actual installation.

Toggles Lower Display



Operation:

Adjust trim to full UP position. The Lower display should flash "uP".



Sets as the top limit position.

Adjust trim to full DOWN position. The Lower display should flash "dn".



Sets as the bottom limit position.

If the engine trim is between 45% and 55% down, the limits cannot be set, and the display show "CEnt" to show that the drive is in mid-position.



Press buttons simultaneously to resets to defaults. The "dn" or "uP" should start flashing again.



to select 2 or 4 stroke engine

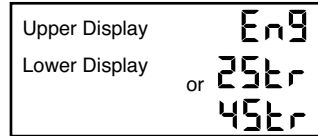

Default

to select 6 or 12 pole Tachometer signal

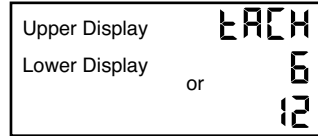

Default

to select Tachometer Signal Level

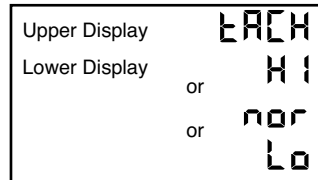

Default

to select Fuel Level Sender Type

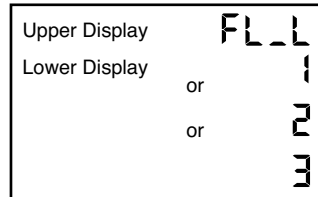

(Default)
AMS (240-33.5 ohms)
EMS (10-180 ohms)
YAMAHA 2001 Sender
(105-5 ohms) (Not normally
used in USA)

AMS = American Marine Sender
EMS = European Marine Sender

to adjust Trim Sensor Limits

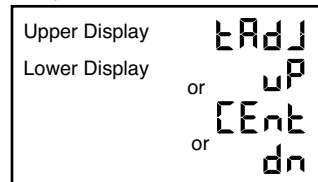

Upper Limit Set
Engine trim is
between 45%
and 55% down
Lower Limit Set

“Other” Mode

Note: Please refer to owners manual for proper settings.



“Other” Mode

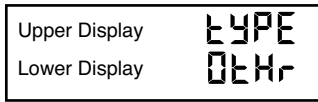

“MAIN” Tachometer set-up screen.

Select the Tachometer Signal setting using either factory settings or variable settings, or adjust setting to match known shop tachometer.

Toggles Lower Display



Tachometer set up screen

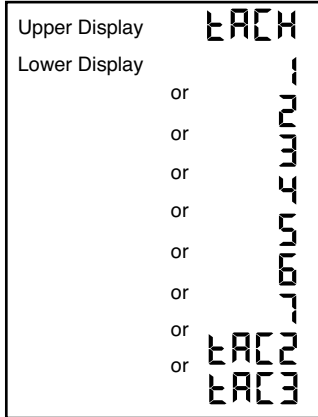

- (Default) 2 pulses/rev (4 cyl)
- 3 pulses/rev (6 pole)
- 4 pulses/rev (8 cyl)
- 5 pulses/rev (10 pole)
- 6 pulses/rev (12 pole)
- 8 pulses/rev
- 10 pulses/rev (20 pole)
- uses TAC2 settings (see below)
- uses TAC3 settings (see below)

TAC2

This screen allows adjustable settings for engines which typically use a magnetic pickup to count teeth on a fly wheel or a pulley drive alternator. The number selected represents pulses/rev.



TAC2 - Select tAC2 from MAIN screen

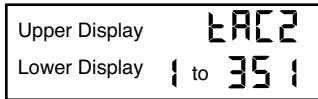

Toggles Lower Display



Displays selected pulses/rev (Max input frequency = 15KHz)
Note: The “MAIN” tachometer set-up screen must display “tAC2” to enable this screen. Otherwise lower display shows “—”

TAC3

This screen allows adjustable settings for engines with an unknown number of pulses/rev. A known good shop tachometer can be used to measure the engine RPM and the tachometer display adjusted to match the shop tachometer.

TAC3 - Select tAC3 from MAIN screen

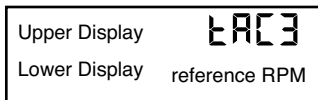

Toggles Lower Display



Displays RPM measured from a running engine.
Note: The “MAIN” tachometer set-up screen must display “tAC3” to enable this screen. Otherwise lower display shows “—”



Signal Level

The default values are usually correct but can be changed if needed.

Toggles Lower Display



to select Tachometer Signal Level

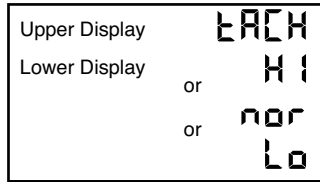

Default depends on application.



Engine Temperature

Allows selection of sensor used for engine temperature. (See Engine Manual)

Toggles Lower Display



to select Engine Temperature Sensor

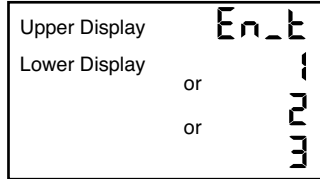

Default depends on application.

Water Temp AMS 100-250°F (40-120°C)

Water Temp EMS 40-120°C

Cylinder Head Temp FMS 60-220°F (20-100°C)

AMS = American Marine Sender
EMS = European Marine Sender
FMS = Faria Marine Sender



Oil Pressure Sender

Allows selection of sensor used for oil pressure. (See Engine Manual)

Toggles Lower Display



to select Oil Pressure Sensor

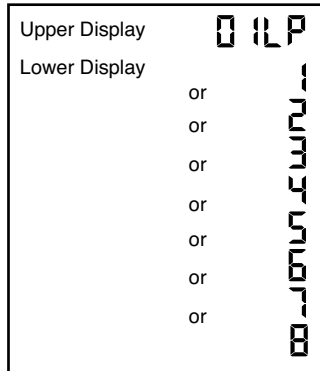

(Default) AMS 0-80 PSI

AMS 0-100 PSI

AMS 0-150 PSI

AMS 0-400 PSI

EMS 0-80 PSI

EMS 0-150 PSI

EMS 0-350 PSI

EMS 0-400 PSI

AMS = American Marine Sender
EMS = European Marine Sender



Fuel Level Sender

Allows selection of sensor used for fuel level. (See Engine Manual)

Toggles Lower Display



to select Fuel Level Sender Type

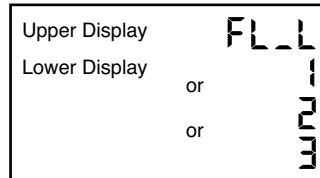

Default

1 = American Marine Sender (240-33.5 ohms)

2 = European Marine Sender (10-180 ohms)

3 = YAMAHA 2001 Sender (105-5 ohms)

(Not normally used in USA)

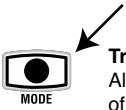

Trim Sensor
 Allows selection of sensor used for trim.
 (See Engine Manual)

Toggles Lower Display



to select Trim Sensor

Upper Display	tSEL	OMC Outboard
Lower Display	-- 1 2 3 4 5 6 7 8 9 0 --	Mercury / Force
or		Volvo SX (MD Mod)
or		Force (70 & 75 HP only)
or		OMC Cobra Stern
or		OMC Sea Stern Drive
or		Yamaha 1996
or		Yamaha 1997-2000
or		Volvo SX Cobra/ Volvo SX(HU Mod, NC Mod/ Volvo DP-S (NC Mod)*
or		Volvo DP (White)*
or		10
	11	

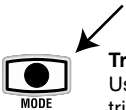

Trim Sensor Limits
 Used to calibrate the trim display to the actual installation.

Toggles Lower Display



to adjust Trim Sensor Limits

Upper Display	tADJ	Upper Limit Set
Lower Display	uP CEnt dn	Engine trim is between 45% and 55% down
or		Lower Limit Set
or		

Operation:

Adjust trim to full UP position. The Lower display should flash "uP".

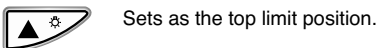

Adjust trim to full DOWN position. The Lower display should flash "dn".

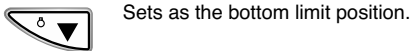

If the engine trim is between 45% and 55% down, the limits cannot be set, and the display show "CEnt" to show that the drive is in mid-position.

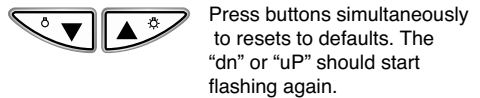

To Pilot II

Harness HN0363 4 - pin connector Yamaha adaptor

4- pin connector(CN0082)

Pin A	Yellow	+12 Ignition
Pin B	Black	Ground
Pin C	Gray	Tachometer Signal
Pin D	Pink	Trim Sensor

ECR 2065 2/12/02

To Engine

Shrink Tubing
or Wrap

Black
(Grnd)

(Eng. Temp.
Warning)
Gray

Pink
(Trim Sensor)

From 6 - pin
connector (Pin B)

Multi-bullets
to Yamaha Engine
Harness

(Fuel Flow
Transducer Grnd)

Black Shield

Yellow

Black

Black

Gray

Yellow
(Ignition)

Black
(Grnd)

Black
(Grnd)

Green
(Tach Signal)

Harness HN0363

6 - pin connector

Yamaha adaptor

6- pin connector(CN0083)

Pin A	Green/Red	Oil Press. / Warning
Pin B	Gray	Engine Temp. / Warning
Pin C	Pink	Fuel Level
Pin D	Green/White	Yamaha 2 stroke-oil Yamaha 4 stroke-hot
Pin E	White	Fuel Flow
Pin F	Red	Fuel Flow Sensor Power

ECR 2065 2/12/02

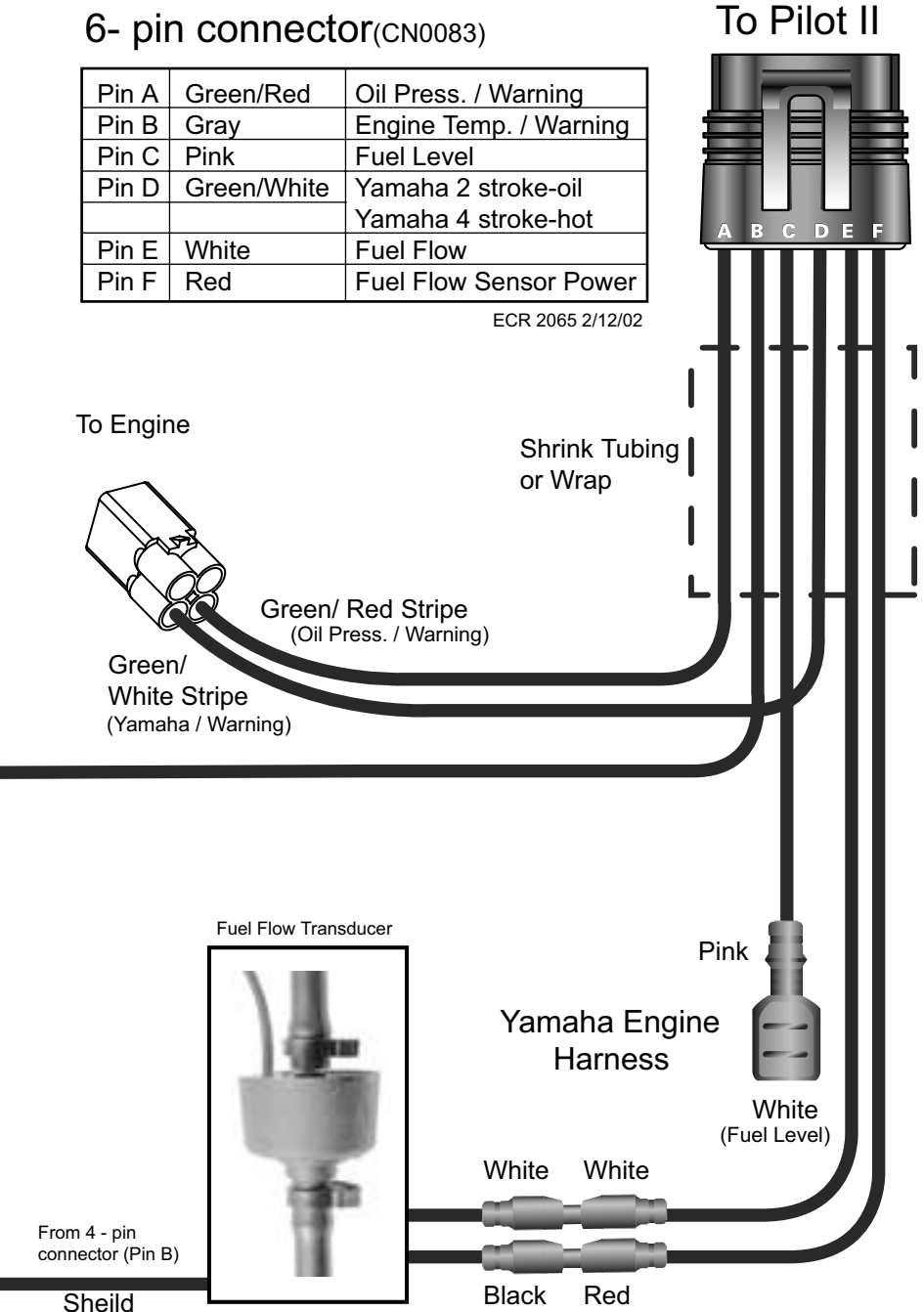

To Pilot II

Harness HN0366

4 - pin connector

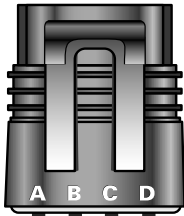

4- pin connector(CN0082)

Pin A	Purple	+12 vDC Ignition
Pin B	Black	Ground
Pin C	Gray	Tachometer Signal
Pin D	Green/White	Trim Sensor

ECR 2152 03/07/02

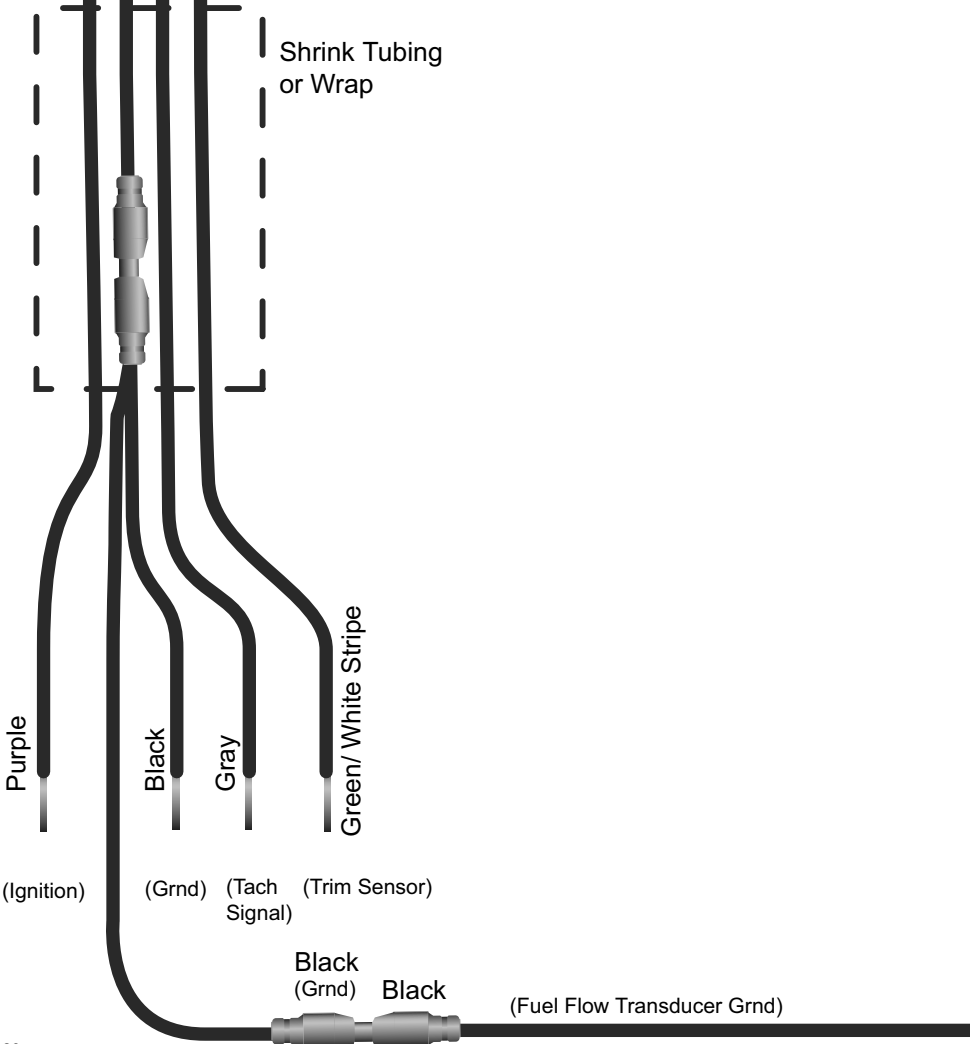

To Pilot II

Harness HN0366 6 - pin connector



6- pin connector(CN0083)

Pin A	Lt. Blue	Oil Press Sender Sig.
Pin B	Tan	Engine Temp
Pin C	Pink	Fuel Level
Pin D	Plug	Not Used
Pin E	Pink/Yellow	Fuel Flow Signal
Pin F	Red/Blue	Fuel Flow Sen. Power

ECR 2152 03/07/02

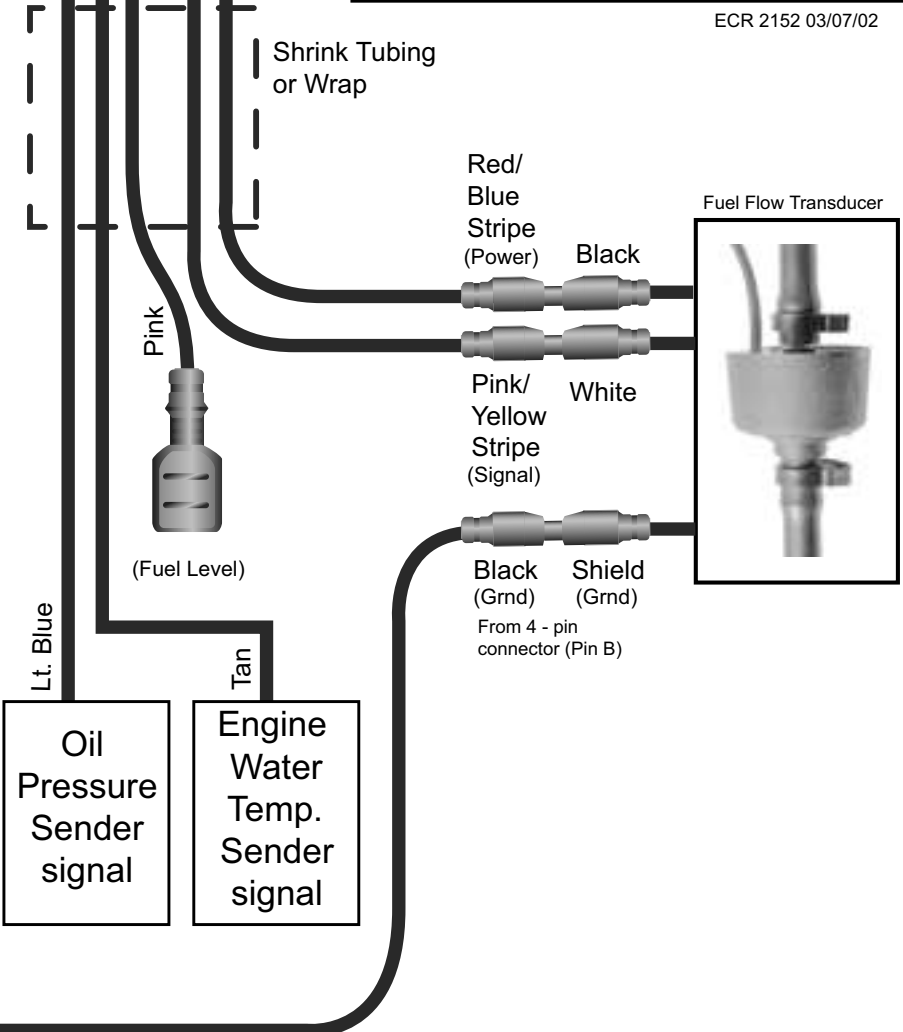

To Pilot II

Harness HN0374

4 - pin connector

Honda Adaptor

4- pin connector(CN0082)

Pin A	Blue/Yellow	+12 vDC Ignition
Pin B	Black	Ground
Pin C	Gray	Tachometer Signal
Pin D	Plug	N/A

ECR 3313 03/07/02

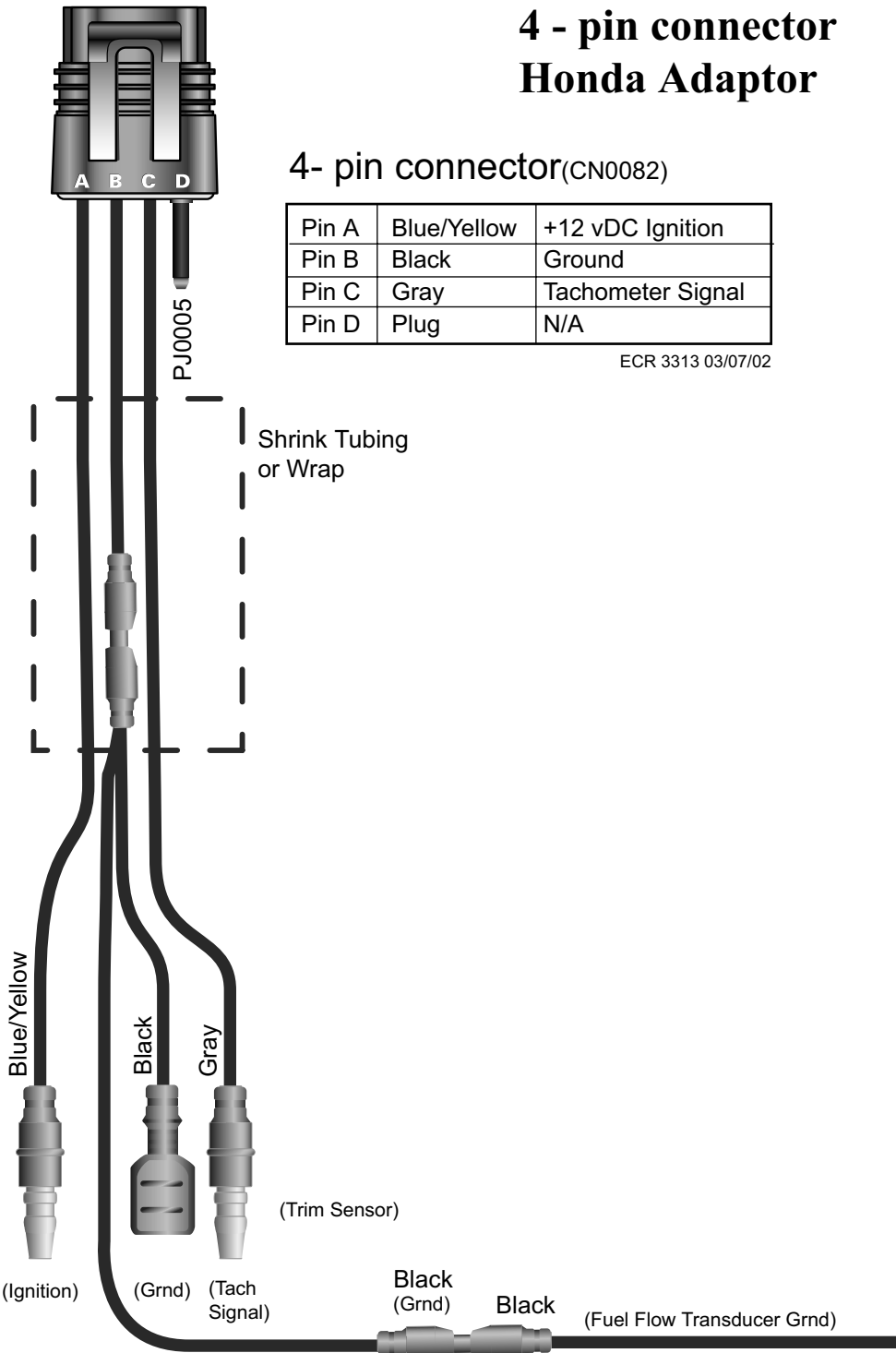

To Pilot II

Harness HN0374 6 - pin connector Honda Adaptor

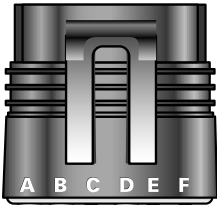

6- pin connector(CN0083)

Pin A	Plug	Not Used
Pin B	Plug	Not Used
Pin C	Pink	Fuel Level
Pin D	Plug	Not Used
Pin E	Pink/Yellow	Fuel Flow Signal
Pin F	Red/Blue	Fuel Flow Sen. Power

ECR 3313 03/07/02

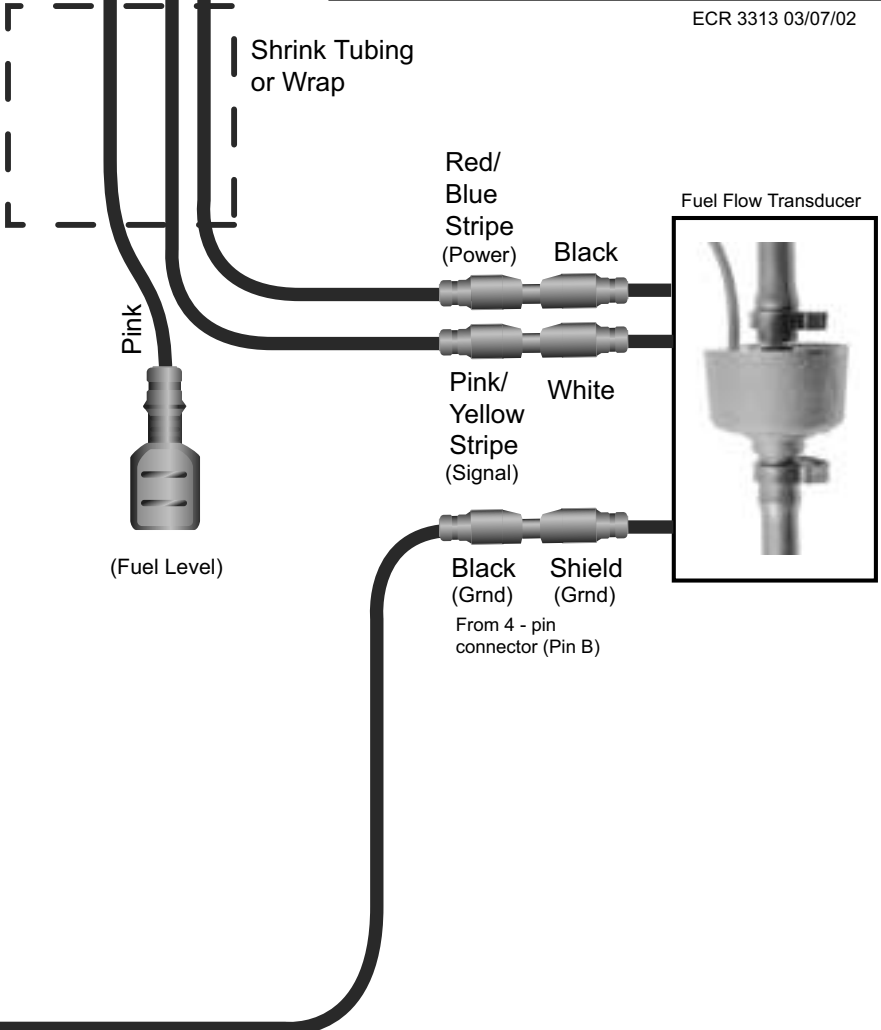

Notes:

